



FLECK 4650
SERVICE MANUAL

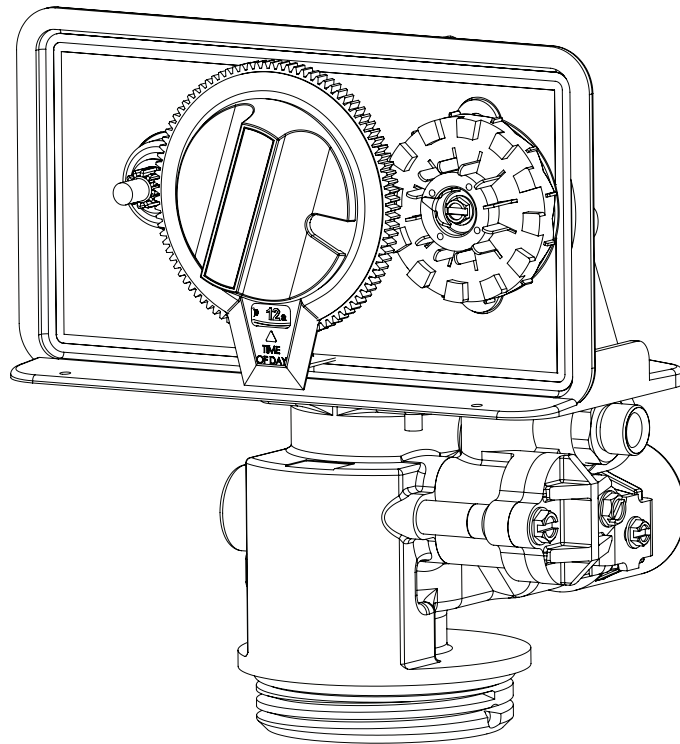

TABLE OF CONTENTS

JOB SPECIFICATION SHEET	2
INSTALLATION.....	2
CONTROL VALVE DRIVE ASSEMBLY.....	3
CONTROL DRIVE ASSEMBLY FOR CLOCK.....	5
BYPASS VALVE ASSEMBLY	7
WATER CONDITIONER FLOW DIAGRAMS.....	8
SERVICE INSTRUCTIONS	10
TROUBLESHOOTING.....	12
SERVICE ASSEMBLY.....	13

JOB SPECIFICATION SHEET

Job Number: _____

Model Number: _____

Water Test: _____

Capacity Per Unit: _____

Mineral Tank Size: _____ Diameter: _____

Height: _____

Brine Tank size and Salt Setting per Regeneration: _____

1. Type of Timer:

- A. "L"
- B. 7 Day
- C. 12 Day

2. Day/Time of Regeneration:

3. Drain Line Flow Control: **gpm**

4. Brine Refill Rate: **gpm**

5. Injector Size#:

INSTALLATION

The water softener should be installed with the inlet, outlet and drain connections made in accordance with manufacturer's recommendations and to meet applicable plumbing codes.

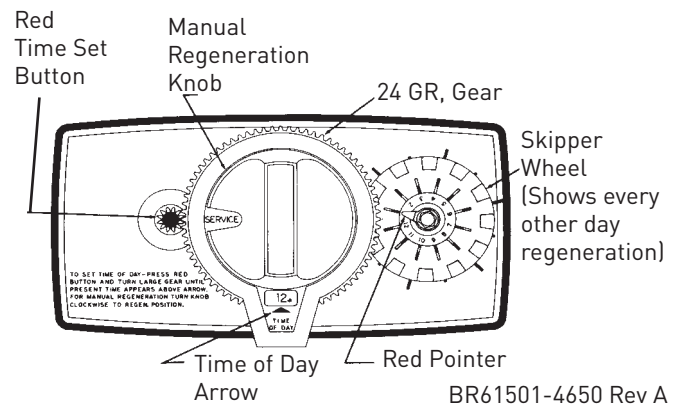

Figure 1

1. Manually index the softener control into the service position and let water flow into the resin tank. When the water flow stops, open a softened water tap until all air is released from the lines, then close the tap.

NOTE: The various regeneration positions may be dialed manually by turning the knob on the front of the control until the indicator shows that the softener is in the desired position.

2. Manually index the control to the backwash position and allow water to flow at the drain for 3 or 4 minutes.
3. Remove back cover plate.
4. Make sure that the salt dosage is set as recommended by the manufacturer. Manually index the control to the brine fill position and allow the brine tank to fill to the top of the air check.
5. Manually index the control to the brine draw position and allow the control to draw water from the brine tank until it stops.
6. Plug in the electrical cord and look in the sight hole in the back of the motor to see that it is running. Set the days that regeneration is to occur by sliding tabs on skipper wheel outward to expose trip fingers. Each tab is one day. Finger at red pointer is tonight. Moving clockwise from red pointer, extend or retract fingers to obtain the desired regeneration schedule.
7. Manually advance the control to the beginning of the brine fill position; and allow the control to return to the service position automatically.
8. Fill the brine tank with salt.
9. Replace back cover on the control.
10. Make sure that any bypass valving is left in the normal service position.

CALIFORNIA PROPOSITION 65 WARNING

⚠ WARNING: This product contains chemicals known to the State of California to cause cancer or birth defects or other reproductive harm.

4650 CONTROL VALVE ASSEMBLY

Item No.	QTY	Part No.	Description
1	1	465001-001	4650, SOF, DNF, CLK, 12DA, 12060, HW 1--, .25, LES, NA2, 1600, SOFT
1	1	465001-002	4650, SOF, DNF, CLK, 12DA, 12060, HW 0--, .25, LES, NA2, 1600, LWAT
1	1	465001-003	4650, SOF, DNF, CLK, 12DA, 24-60, HW 1--, .5-, LES, NA2, 1600, SOFT

Above part numbers DO NOT include the following parts.

- Cover
- Bypass
- Yoke
- Flow Washer

See 4650 accessories page for options.

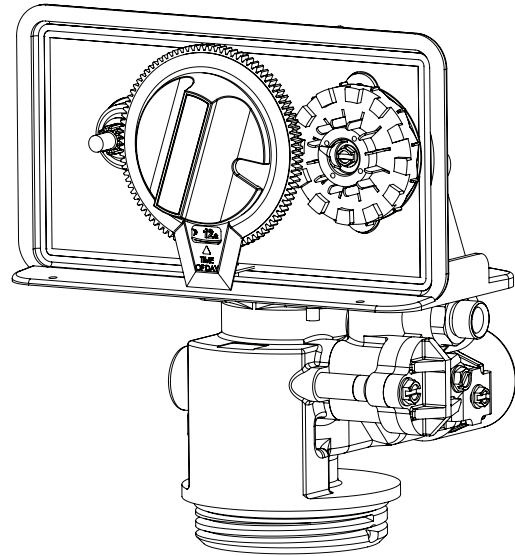

CONTROL VALVE DRIVE ASSEMBLY

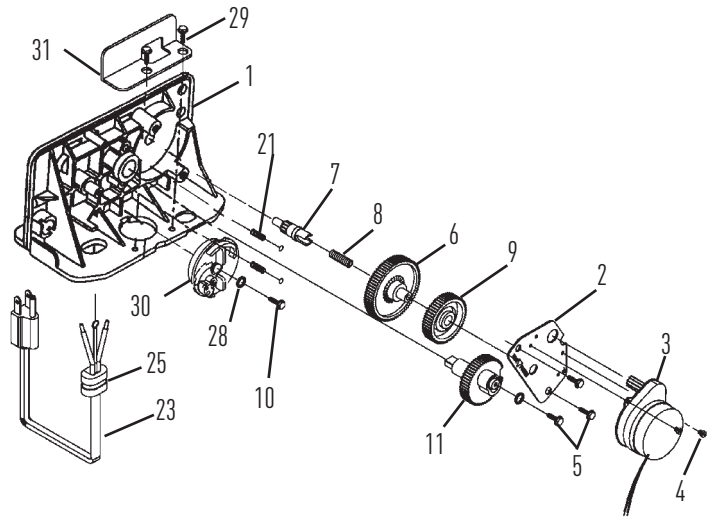
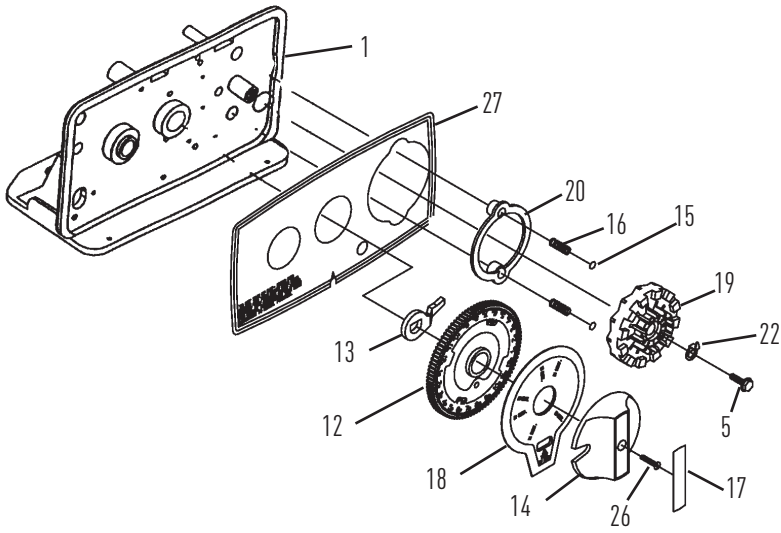

BR61501-4650 Rev A

CONTROL VALVE DRIVE ASSEMBLY

CONTINUED

Item No.	QTY	Part No.	Description	Item No.	QTY	Part No.	Description
1	1	15494-01	"L" Housing - w/Pin	18	1	14176	Valve Position Dial - Standard
2	1	13175	Motor Mounting Plate	19	1	14381	Skipper Wheel Assembly - 12 Day
3	1	18743-1	Motor - 120V, 60 Hz, 1/30 rpm	1	1	14860	Skipper Wheel Assembly - 7 Day
	1	18752-1	Motor - 100V, 50 Hz, 1/30 rpm	20	1	13864	Skipper Wheel Ring
	1	18824-1	Motor - 230V, 50 Hz, 1/30 rpm	21	2	14457	Spring - Detent - Main Gear
	1	18826-1	Motor - 24V, 50 Hz, 1/30 rpm	22	1	13014	Regeneration Pointer
	1	19659-1	Motor - 24V, 60 Hz, 1/30 rpm	23	1	11842	Electrical Cord - Standard
	1	19660-1	Motor - 230V, 60 Hz, 1/30 rpm	24	2	12681	Wire Connector (Not Shown)
4	3	11384	Screw - Motor Mtg. & Ground Wire	25	1	13547	Strain Relief
5	3	13296	Screw - Component Mounting	26	1	15151	Screw - Knob
6	1	13017	Idler Gear	27	1	14331	Front Label - Silver on Black
7	1	13018	Idler Pinion	28	1	12037	Washer
8	1	13312	Spring - Idler	29	2	12473	Screw-Drive Mounting
9	1	13164	Drive Gear	30	1	60514	Brine Cam Assembly, 5600, 3-16
10	1	40214	Screw - Brine Cam	1	1	60514-00	Brine Cam Assembly, 5600, Less Salt Label
11	1	13170	Main Gear & Shaft	1	1	60514-01	Brine Cam Assembly, 5600, 6-36
12	1	19205-01	24-Hour Gear Assembly, Silver	1	1	60514-02	Brine Cam Assembly, 5600, Minute
13	1	13011	Cycle Actuator Gear	31	1	40327	Support Bracket (Hot water Only)
14	1	14177	Knob - Manual Regeneration				
15	4	13300	Ball - 1/4-inch Dia.				
16	2	13311	Spring - Detent - Skipper Wheel				
17	1	14207	Knob Label - Silver				

CONTROL DRIVE ASSEMBLY FOR CLOCK

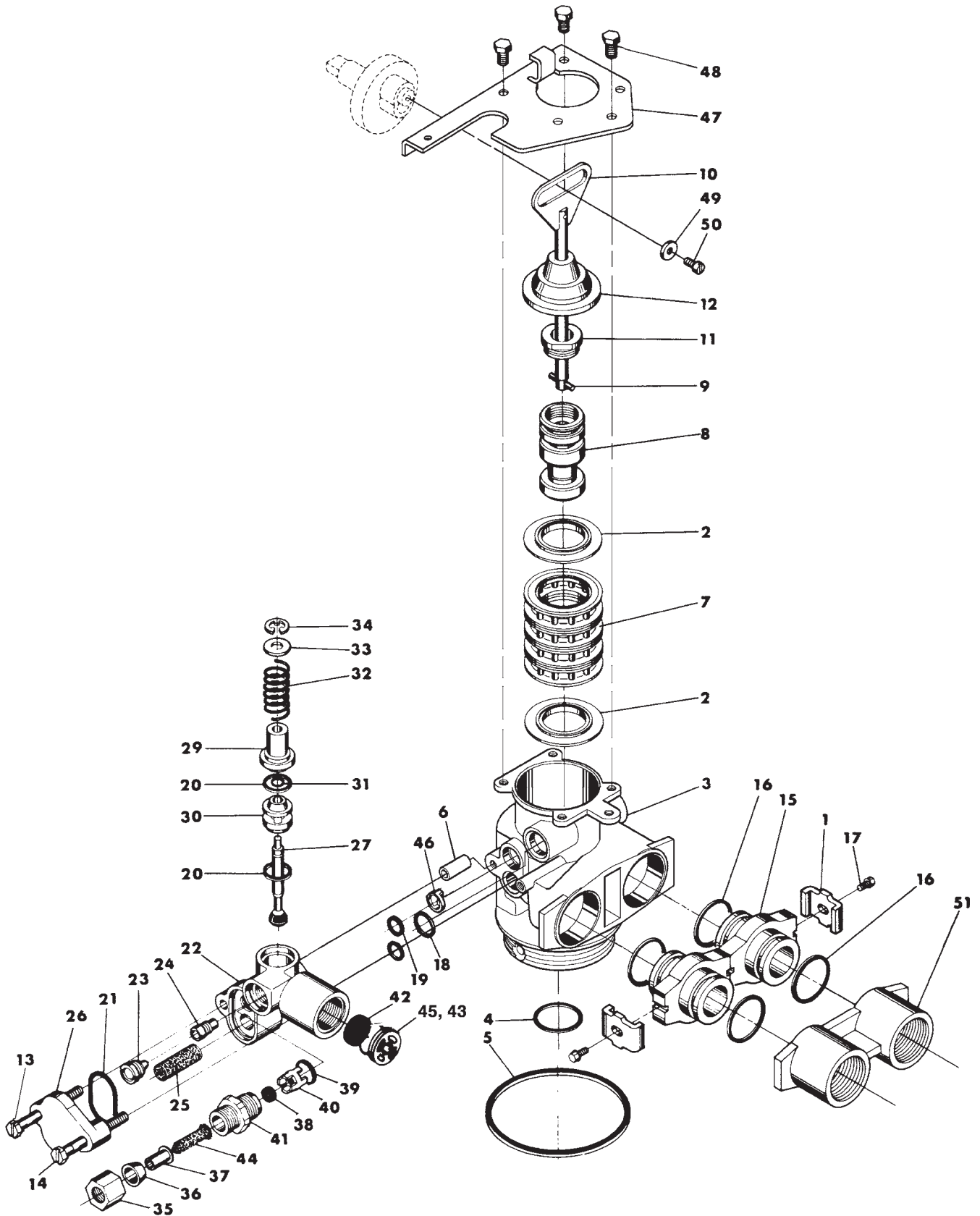

BR61500-4650 Rev A

CONTROL DRIVE ASSEMBLY FOR CLOCK

CONTINUED

Item No.	QTY	Part No.	Description	Item No.	QTY	Part No.	Description
1	2	13255	Adapter Clip	31	1	12550-01	Quad Ring - Hot Water
2	5	13242	Seal		1	12550	Quad Ring - Cold Water
	5	17772	Seal, 4650, HW, Chloramine resistant	32	1	11973	Spring - Brine Valve
3	1	40319	Valve Body	33	1	16098	Washer - Brine Valve
4	1	13304	O-ring - Distributor Tube - 1-inch	34	1	11981-03	Retaining Ring, Copper
	1	13304-01	O-ring, -121, 560CD, HW	35	1	10329	BLFC Fitting Nut
5	1	10381	O-ring - Top of Tank	36	1	10330	BLFC Ferrule
	1	10381-01	O-ring, -231, 560CD, HW	37	1	10332	BLFC Tube Insert
6	1	13361	Stand-Off	38-41	1	60022-12	BLFC, 0.125 GPM (0.375 lbs NaCl/min)
7	4	14241-01	Spacer - Hot Water		1	60022-25	BLFC, 0.25 GPM (0.75 lbs NaCl/min)
	4	14241	Spacer - Cold Water		1	60022-50	BLFC, 0.50 GPM (1.5 lbs NaCl/min)
8	1	13247	Piston - Standard		1	60022-100	BLFC, 1.0 GPM (3 lbs NaCl/min)
9	1	10696	Piston Pin	42	1		DLFC Button - Specify Size
10	1	13001	Piston Rod Assembly	43	1	13173	DLFC Button Retainer
11	1	12953	Piston Retainer	44	1	12767	Screen - Brine Valve
12	1	61411	End Plug Assembly, Brass - Hot Water	45	1	15348	O-ring - DLFC (not shown)
	1	13446	End Plug Assembly, Std., White - Cold Water	46	1	13497	Air Disperser
13	1	13387	Screw - Injector Mounting	47	1	13546	End Plug Retainer
14	1	13315	Screw - Injector Mounting		1	40324	End Plug Retainer, Hot Water
15	2	19228	Adapter Coupling	48	3	12112	Screw
16	4	13305	O-ring - Adapter Coupling	49	1	13363	Washer
17	2-4	13314	Screw - Adapter Coupling	50	1	13296	Screw
18	1	12638	O-ring - Drain	51	1	13398	Yoke, Brass, 1-inch NPT
	1	12638-01	O-ring, -013, 560CD, Injector, HW		1	13708	Yoke, Brass, 3/4-inch NPT
19	2	13301	O-ring - Injector				
	2	13301-01	O-ring, -011, 560CD, HW				
20	2	13302-01	O-ring - Brine Spacer - Hot Water				
	2	13302	O-ring - Brine Spacer - Cold Water				
21	1	13303	O-ring - Injector Cover				
	1	13303-01	O-ring, -021, 560CD, HW				
22	1	13163	Injector Body				
23	1	10225-xx	Injector Nozzle - Hot Water				
	1	10913-xx	Injector Nozzle - Cold Water				
24	1	10226-xx	Injector Throat - Specify Size - Hot Water				
	1	10914-xx	Injector Throat - Specify Size - Cold Water				
25	1	10227	Injector Screen				
26	1	13166	Injector Cover				
27	1	13172-03	Brine Valve Stem Assembly - Hot Water				
	1	13172-02	Brine Valve Stem Assembly - Cold Water				
29	1	13165	Brine Valve Cap				
30	1	13167	Brine Valve Spacer				

4650 VALVE ACCESSORIES

Covers

- 60226-11Cover, 5600, Designer I, Blk/Blk
 60226-22Cover, 5600, Designer I, Blue/Blue



COVERS

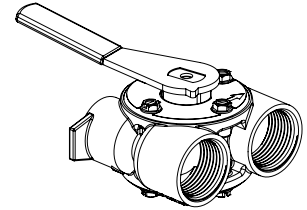

BYPASSES

Bypasses

- 60041SS.....1" Bypass, SS, NPT
 60040SS.....3/4" Bypass, SS, NPT

Yokes

- 13708-401" Yoke, Sweat
 41026-011" Yoke, SS, NPT
 42690.....3/4" Yoke, Sweat
 41027-013/4" Yoke, SS, NPT

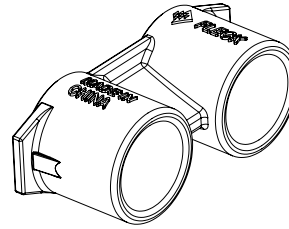

YOKES

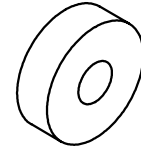

WASHERS

Washers

- 19153.....Washer, Flow, 0.6 GPM
 19152.....Washer, Flow, 0.8 GPM
 12085.....Washer, Flow, 1.2 GPM
 19150.....Washer, Flow, 1.3 GPM
 12086.....Washer, Flow, 1.5 GPM
 19149.....Washer, Flow, 1.7 GPM
 12087.....Washer, Flow, 2.0 GPM
 12088.....Washer, Flow, 2.4 GPM
 12089.....Washer, Flow, 3.0 GPM
 12090.....Washer, Flow, 3.5 GPM
 12091.....Washer, Flow, 4.0 GPM
 19147.....Washer, Flow, 4.5 GPM
 12092.....Washer, Flow, 5.0 GPM
 17814.....Washer, Flow, 6.0 GPM
 12408.....Washer, Flow, 7.0 GPM

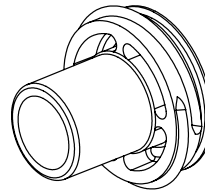

RETAINER

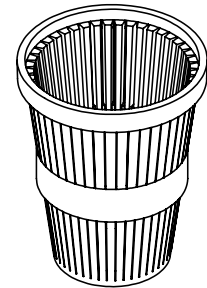

COLLECTORS

Retainer

- 13173-01Retainer, DLFC Button, w/O-ring

Collectors

- 13700-10Collector, Top, 1", Hot Water
 13700-11Collector, Top, 1", Hot Water Wide Slot
 13700-12Collector, Top, 1", Hot Water Narrow Slot
 13748.....Screw (for mounting upper collectors)

4650 VALVE ASSEMBLIES

BLFC

60022-12BLFC, 0.125 GPM (0.375 lbs NaCl/min)
60022-25BLFC, 0.25 GPM (0.75 lbs NaCl/min)
60022-50BLFC, 0.50 GPM (1.5 lbs NaCl/min)
60022-100BLFC, 1.0 GPM (3 lbs NaCl/min)

Injector Nozzles

10225-0Nozzle, Injector, #0, SS (8" Tank)
10225-1Nozzle, Injector, #1, SS (9" & 10" Tank)
10225-2Nozzle, Injector, #2, SS (12" Tank)
10225-3Nozzle, Injector, #3, SS (13" Tank)

Injector Throats

10226-0Throat, Injector, #0, SS (8" Tank)
10226-1Throat, Injector, #1, SS (9" & 10" Tank)
10226-2Throat, Injector, #2, SS (12" Tank)
10226-3Throat, Injector, #3, SS (13" Tank)

Labels

18663Label, Brine Valve Cam, 1.5-8 lbs.
41124Label, Lbs. Salt, 3-16
41125Label, Lbs. Salt, 6-32
41126Label, Brine Valve Cam, Minute
41127Label, Brine Valve Cam, 1.5-7 kg
41128Label, Brine Valve Cam, 3-14 kg

Switch

60320-03Switch Assy, 5600 Auxiliary
----------	----------------------------------

Brine Cam Assemblies

60514-00Brine Cam Assy, 5600, Less Salt Label
----------	--

Powerheads

62090-04Pwrhd, 4650/5600, Soft, Clk, 12D, "L", Sil/Blk, 120/60, US Cord
62090-05Pwrhd, 4650/5600, Soft, Clk, 12D, "L", Sil/Blk, 24/60, No Cord

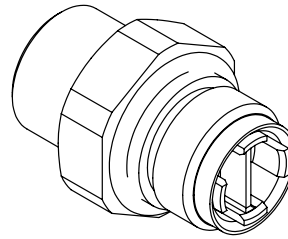

BLFC

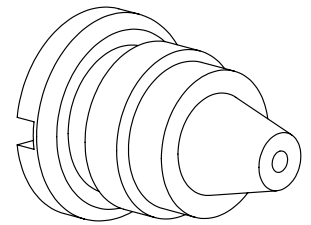

INJECTOR NOZZLES

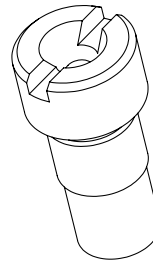

INJECTOR THROATS

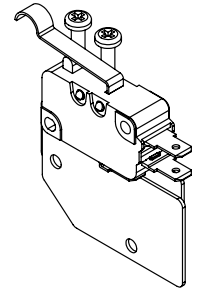

SWITCH

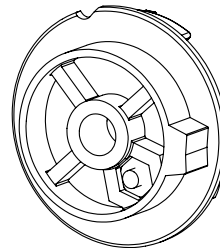

BRINE CAM ASSEMBLIES

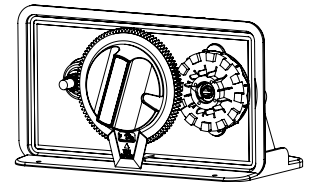

POWERHEADS

WATER CONDITIONER FLOW DIAGRAMS

1 Service Position

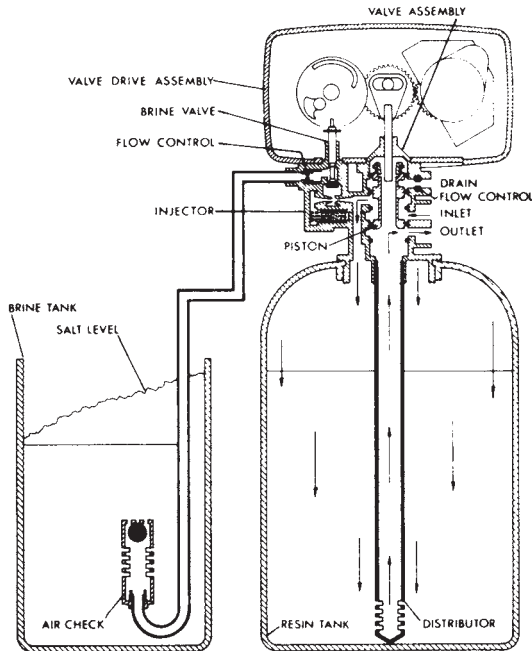

Hard water enters the unit at the valve inlet - flows around the lower piston groove - thru the passage to the top of tank - down thru the resin and enters the distributor as conditioned water. The conditioned water flows up thru the center tube to the valve outlet.

3 Backwash Position (10 Minutes)

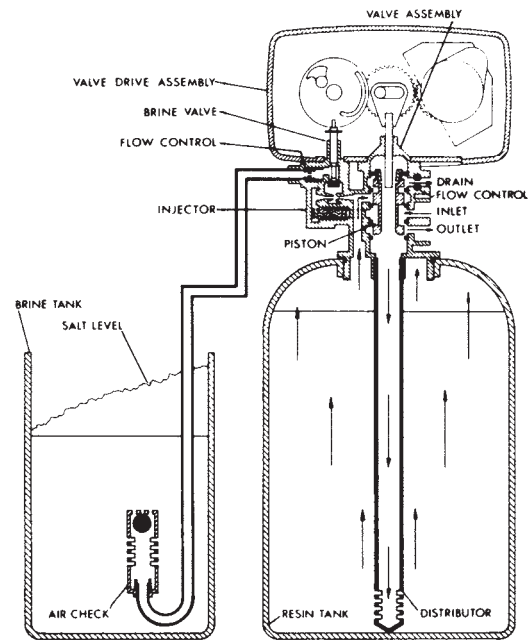

Hard water enters the unit at the valve inlet - flows around the lower piston groove and lower piston land - down thru the center tube and out the distributor - up thru the resin - thru the top of tank passage - around the upper piston groove and out the drain line.

2 Preliminary Rinse Position (5 Minutes)

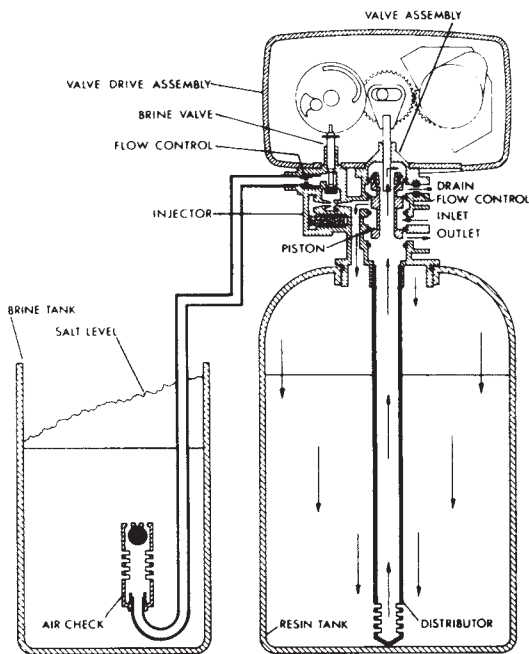

Hard water enters the unit at the valve inlet - flows around the lower piston groove - down thru the top of tank passage - downward thru the resin - up the distributor tube - thru the center hole in the piston - over the top edge of the piston and out the drain line.

4 Brine Position (First Portion of 50 Minute Fixed Cycle)

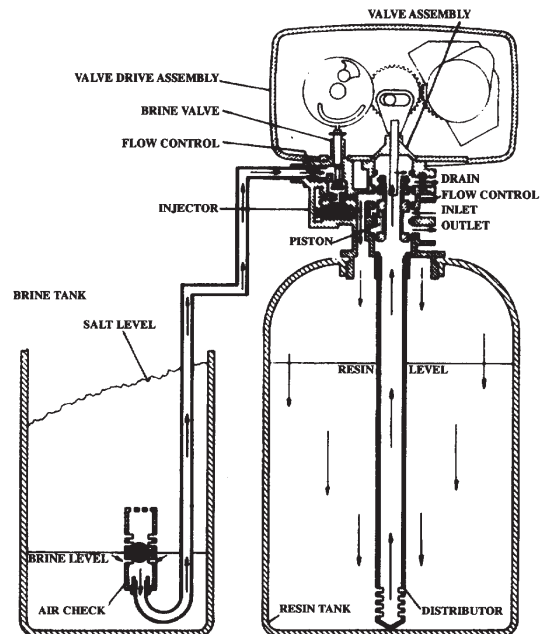

Hard water enters the unit at the valve inlet - flows around the lower piston groove - thru the injector nozzle and orifice to draw brine from the brine tank. The brine flows down thru the resin - into the distributor - up thru the center tube - thru the center hole in the piston and out the drain line.

WATER CONDITIONER FLOW DIAGRAMS

CONTINUED

5 Slow Rinse Position (Last Portion of 50 Minute Fixed Cycle)

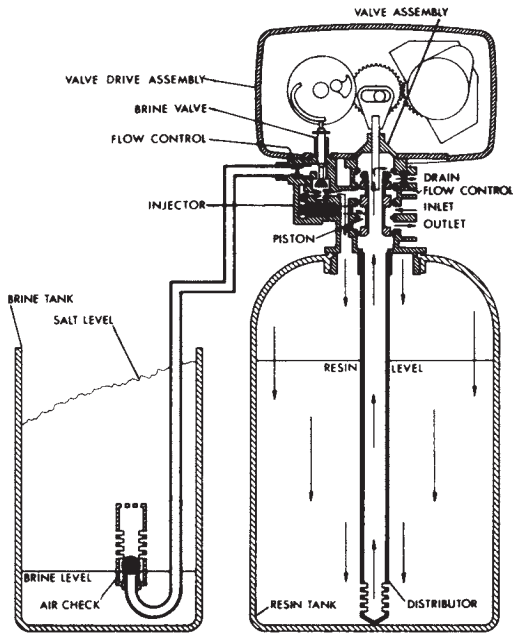

After all the brine has been drawn from the brine tank, hard water continues to enter thru the valve inlet - flows around the lower piston groove - thru the nozzle and orifice - down thru the resin and into the distributor - up thru the center tube - thru the center hole in the piston and out the drain line.

6 Second Backwash Position (10 Minutes)

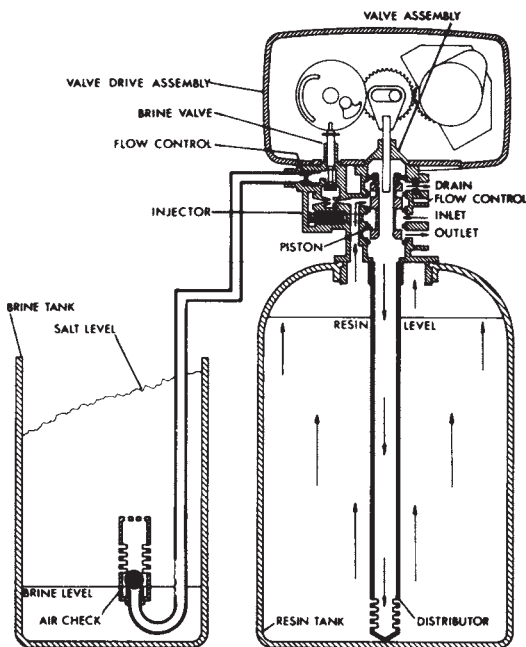

Hard water enters the unit at the valve inlet - flows around the lower piston groove and lower piston land - down thru the center tube and out the distributor - up thru the resin - thru the top of tank passage - around the upper piston groove and out the drain line.

7 Settling Rinse Position (5 Minutes)

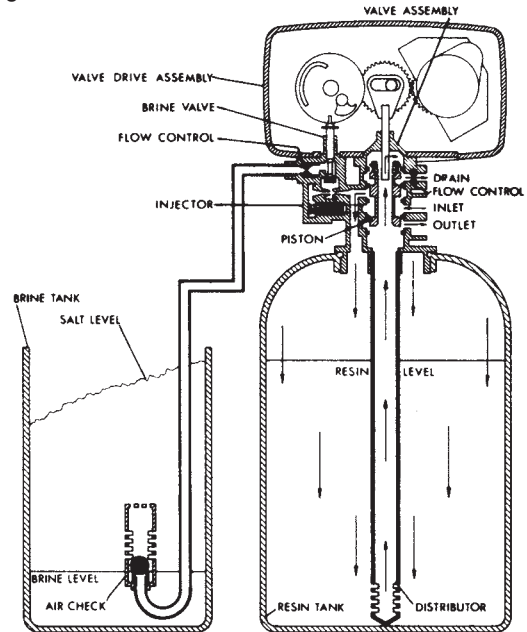

Hard water enters the unit at the valve inlet - flows around the lower piston groove - down thru the top of tank passage - downward thru the resin - up the distributor tube - thru the center hole in the piston - over the top edge of the piston and out the drain line.

8 Brine Tank Fill Position (4 to 24 Minutes Adjustable Cycle)

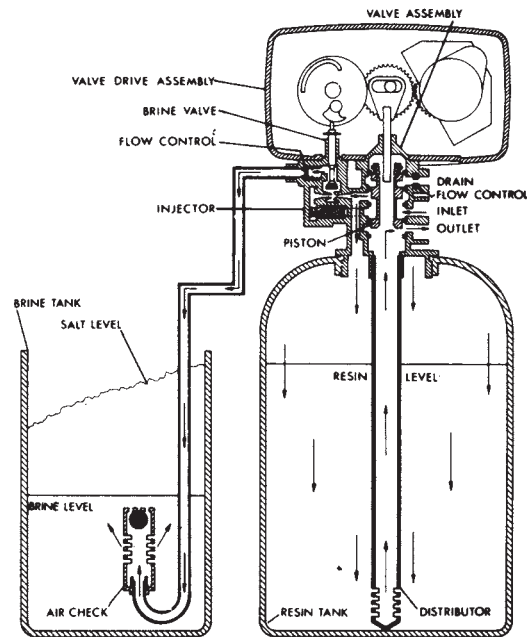

Hard water enters the unit at the valve inlet - flows around the lower piston groove - thru the injector throat - thru the brine valve and flow control to fill the brine tank. Hard water also flows around the lower piston groove - thru the passage to the top of tank - down thru the resin and enters the distributor as conditioned water. The conditioned water flows up thru the center tube to the valve outlet.

SERVICE INSTRUCTIONS

A. TO REMOVE TIME BRINE VALVE, INJECTORS, AND SCREEN

1. Unplug electrical cord from outlet.
2. Turn off water supply to conditioner:
 - a. If the conditioner installation has a "three valve" bypass system, first open the valve in the bypass line, then close the valves at the conditioner inlet and outlet.
 - b. If the conditioner has an integral bypass valve, put it in the bypass position.
 - c. If there is only a shut-off valve near the conditioner inlet, close it.
3. Relieve water pressure in the conditioner by putting the control in the backwash position momentarily. Return the control to the service position.
4. Disconnect brine tube and drain line connections at the injector body.
5. Remove the two injector body mounting screws. The injector and brine module can now be removed from the control valve. Remove and discard valve body o-rings.
6. To replace brine valve:
 - a. Pull brine valve from injector body, also remove and discard o-ring at bottom of brine valve hole.
 - b. Apply silicone lubricant to new o-ring and reinstall at bottom of brine valve hole.
 - c. Apply silicone lubricant to o-ring on new valve assembly and press into brine valve hole, shoulder on bushing should be flush with injector body.
7. To replace injectors and screen:
 - a. Remove injector cap and screen, discard o-ring. Unscrew injector nozzle and throat from injector body.
 - b. Screw in new injector throat and nozzle. Be sure they are seated tightly. Install a new screen.
 - c. Apply silicone lubricant to new o-ring and install around oval extension on injector cap.
8. Apply silicone lubricant to three new o-rings and install over three bosses on injector body.
9. Insert screws with washers through injector cap and injector. Place this assembly through hole in timer housing and into mating holes in the valve body. Tighten screws. Be sure to reinstall brass spacers with injector on Model 4600 valve.
10. Reconnect brine tube and drain line.
11. Return bypass or inlet valving to normal service position. Water pressure should now be applied to the conditioner, and any bypass line shut off.
12. Check for leaks at all seal areas. Check drain seal with the control in the backwash position.
13. Plug electrical cord into outlet.
14. Set time of day and cycle the control valve manually to ensure proper function. Make sure the control valve is returned to the service position.

15. Make sure there is enough brine in the brine tank.
16. Rotate program wheel counterclockwise until it stops at regeneration position.
17. Start regeneration cycle manually if water is hard.

B. TO REPLACE TIMER

1. Unplug electrical cord from outlet.
2. Turn off water supply to conditioner:
 - d. If the conditioner installation has a "three valve" bypass system, first open the valve in the bypass line, then close the valves at the conditioner inlet and outlet.
 - e. If the conditioner has an integral bypass valve, put it in the bypass position.
 - f. If there is only a shut-off valve near the conditioner inlet, close it.
3. Relieve water pressure in the conditioner by putting the control in the backwash position momentarily. Return the control to the service position.
4. Remove the control valve back cover.
5. Remove screw and washer at drive yoke. Remove timer mounting screws. The entire timer assembly will now lift off easily.
6. Put new timer on top of valve. Be sure drive pin on main gear engages slot in drive yoke (rotate control knob if necessary).
7. Replace timer mounting screws. Replace screw and washer at drive yoke.
8. Return bypass or inlet valving to normal service position. Water pressure should now be applied to the conditioner, and any bypass line shut off.
9. Plug electrical cord into outlet.
10. Set time of day, program wheel, and salt usage. Cycle the control valve manually to ensure proper function. Make sure the control valve is returned to the service position.
11. Replace the control valve back cover. Be sure grommet at cable hole is in place.
12. Make sure there is enough brine in the brine tank.
13. Rotate program wheel counterclockwise until it stops at regeneration position.
14. Start regeneration cycle manually if water is hard.

SERVICE INSTRUCTIONS *CONTINUED*

C. TO REPLACE PISTON ASSEMBLY

1. Unplug electrical cord from outlet.
2. Turn off water supply to conditioner:
 - a. If the conditioner installation has a "three valve" bypass system, first open the valve in the bypass line, then close the valves at the conditioner inlet and outlet.
 - b. If the conditioner has an integral bypass valve, put it in the bypass position.
 - c. If there is only a shut-off valve near the conditioner inlet, close it.
3. Relieve water pressure in the conditioner by putting the control in the backwash position momentarily. Return the control to the service position.
4. Remove the control valve back cover.
5. Remove screw and washer at drive yoke. Remove timer mounting screws. The entire timer assembly will now lift off easily. Remove end plug retainer plate.
6. Pull upward on end of piston yoke until assembly is out of valve.
7. Inspect the inside of the valve to make sure that all spacers and seals are in place, and that there is no foreign matter that would interfere with the valve operation.
8. Take new piston assembly as furnished and push piston into valve by means of the end plug. Twist yoke carefully in a clockwise direction to properly align it with drive gear. Replace end plug retainer plate.
9. Place timer on top of valve. Be sure drive pin on main gear engages slot in drive yoke. Rotate control knob if necessary.
10. Replace timer mounting screws. Replace screw and washer at drive yoke.
11. Return bypass or inlet valving to normal service position. Water pressure should now be applied to the conditioner, and any bypass line shut off.
12. Plug electrical cord into outlet.
13. Set time of day. Cycle the control valve manually to ensure proper function. Make sure the control valve is returned to the service position.
14. Replace the control valve back cover. Be sure grommet at cable hole is in place.
15. Make sure there is enough brine in the brine tank.
16. Rotate program wheel counterclockwise until it stops at regeneration position.
17. Start regeneration cycle manually if water is hard.

D. TO REPLACE SEALS AND SPACERS

1. Unplug electrical cord from outlet.
2. Turn off water supply to conditioner:
 - a. If the conditioner installation has a "three valve" bypass system, first open the valve in the bypass line, then close the valves at the conditioner inlet and outlet.
 - b. If the conditioner has an integral bypass valve, put it in the bypass position.
 - c. If there is only a shut-off valve near the conditioner inlet, close it.
3. Relieve water pressure in the conditioner by putting the control in the backwash position momentarily. Return the control to the service position.
4. Remove the control valve back cover.
5. Remove screw and washer at drive yoke. Remove timer mounting screws. The entire timer assembly will now lift off easily. Remove end plug retainer plate.
6. Pull upward on end of piston rod yoke until assembly is out of valve. Remove and replace seats and spacers with fingers.

TROUBLESHOOTING

Problem	Cause	Correction
Water conditioner fails to regenerate.	Electrical service to unit has been interrupted	Assure permanent electrical service (check fuse, plug, pull chain, or switch)
	Timer is defective.	Replace timer.
	Power failure.	Reset time of day.
Hard water.	By-pass valve is open.	Close by-pass valve.
	No salt is in brine tank.	Add salt to brine tank and maintain salt level above water level.
	Injector screen plugged.	Clean injector screen.
	Insufficient water flowing into brine tank.	Check brine tank fill time and clean brine line flow control if plugged.
	Hot water tank hardness.	Repeated flushings of the hot water tank is required.
	Leak at distributor tube.	Make sure distributor tube is not cracked. Check o-ring and tube pilot.
	Internal valve leak.	Replace seals and spacers and/or piston.
Unit used too much salt.	Improper salt setting.	Check salt usage and salt setting.
	Excessive water in brine tank.	See "Excessive water in brine tank".
Loss of water pressure.	Iron buildup in line to water conditioner.	Clean line to water conditioner.
	Iron buildup in water conditioner.	Clean control and add mineral cleaner to mineral bed. Increase frequency of regeneration.
	Inlet of control plugged due to foreign material broken loose from pipes by recent work done on plumbing system.	Remove piston and clean control.
Loss of mineral through drain line.	Air in water system.	Assure that well system has proper air eliminator control. Check for dry well condition.
	Improperly sized drain line flow control.	Check for proper drain rate.
Iron in conditioned water.	Fouled mineral bed.	Check backwash, brine draw, and brine tank fill. Increase frequency of regeneration. Increase backwash time.
Excessive water in brine tank.	Plugged drain line flow control.	Clean flow control.
	Plugged injector system.	Clean injector and screen.
	Timer not cycling.	Replace timer.
	Foreign material in brine valve.	Replace brine valve seat and clean valve.
	Foreign material in brine line flow control.	Clean brine line flow control.
Softener fails to draw brine.	Drain line flow control is plugged.	Clean drain line flow control.
	Injector is plugged.	Clean injector
	Injector screen plugged.	Clean screen.
	Line pressure is too low.	Increase line pressure to 20 psi
	Internal control leak	Change seals, spacers, and piston assembly.
	Service adapter did not cycle.	Check drive motor and switches.
Control cycles continuously.	Misadjusted, broken, or shorted switch.	Determine if switch or timer is faulty and replace it, or replace complete power head.
Drain flows continuously.	Valve is not programming correctly.	Check timer program and positioning of control. Replace power head assembly if not positioning properly.
	Foreign material in control.	Remove power head assembly and inspect bore. Remove foreign material and check control in various regeneration positions.
	Internal control leak.	Replace seals and piston assembly.

SERVICE ASSEMBLIES

- 60102-00Piston Assembly Cold Water - Softener
- 60102-10Piston Assembly,
Cold Water - Feeder/Filter
- 60102-20Piston Assembly,
Cold Water - Low Water
- 60102-031Piston Assembly - Hot Water - Softener
- 60102-231Piston Assembly, 4650,
560CD CW/HW - Softener
- 60125Seal & Spacer Kit, 5600/9000 Top
- 60125-05Seal & Spacer Kit, 4650, Hot Water
- 60084-XXXXInjector - Cold Water

See Parts List

- ***Injector - Hot Water
- 60032Brine Valve - Cold Water
- 60032-001Brine Valve - Hot Water
- 60510Coupling with Clip and Screws
- 14860Skipper Wheel - 7 Day
- 14381Skipper Wheel - 12 Day

***Hot water injector components are listed separately.

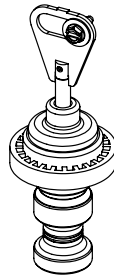

PISTON ASSEMBLY

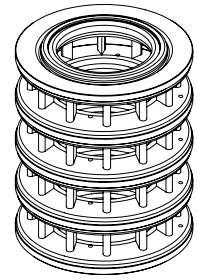

SEAL & SPACER KIT

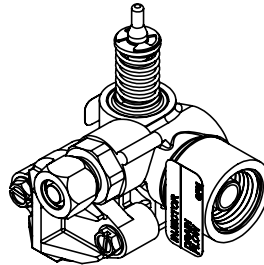

INJECTOR

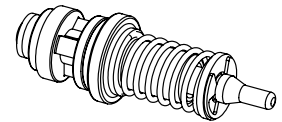

BRINE VALVE

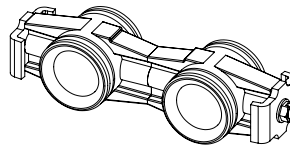

COUPLING

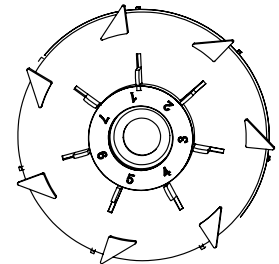

SKIPPER WHEEL, 7 DAY

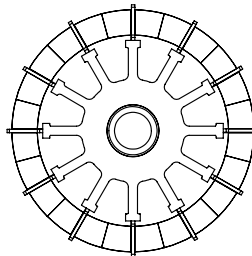

SKIPPER WHEEL, 12 DAY

For Fleck Product Warranties visit:
Fleck para las garantías de los productos visite: } waterpurification.pentair.com
Pour Fleck garanties produit visitez le site :



WATER QUALITY SYSTEMS

5730 NORTH GLEN PARK ROAD, MILWAUKEE, WI 53209
P: 262.238.4400 | WATERPURIFICATION.PENTAIR.COM | CUSTOMER CARE: 800.279.9404 | tech-support@pentair.com

[§]For a detailed list of where Pentair trademarks are registered, please visit waterpurification.pentair.com/brands.
Pentair trademarks and logos are owned by Pentair plc or its affiliates. Third party registered and unregistered trademarks and logos are the property of their respective owners.

40261 REV E MY17 © 2017 Pentair Residential Filtration, LLC All Rights Reserved.